

Classwork

Date :

Homework

Practice :



UKG English

Write the alphabets Aa to Zz.

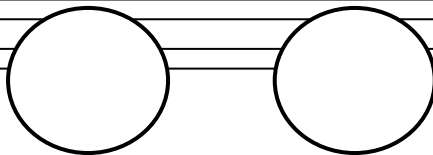
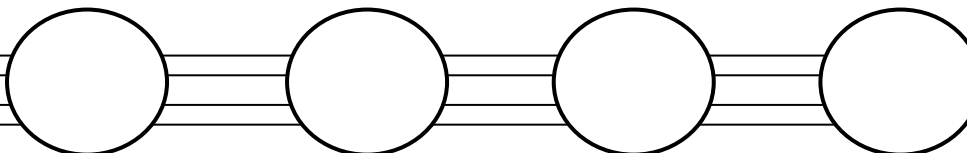
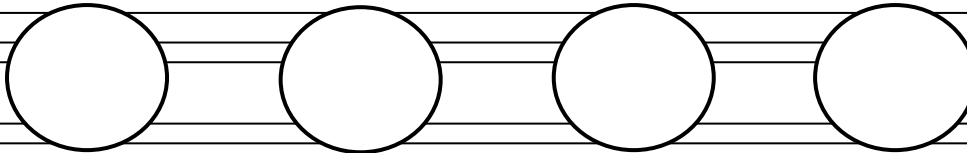
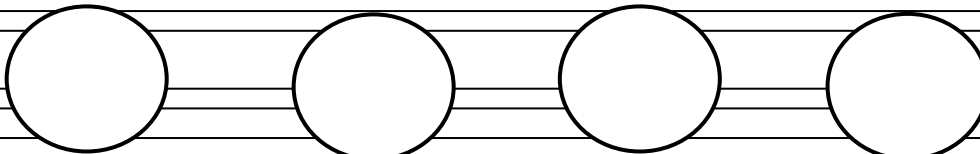
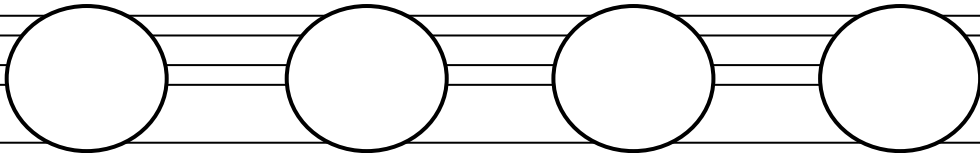
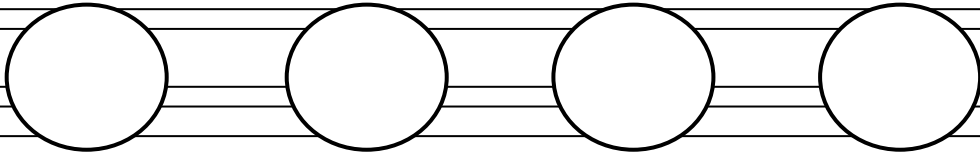
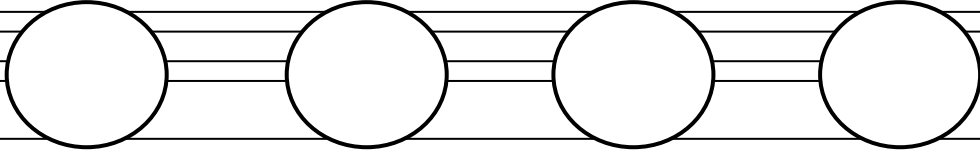

Classwork Date :

Homework Practice :



UKG English

Write only the consonants,

a e

 i

 o

 u

Write down the vowels.

A a E e I i O o U u

Classwork

Date :

Homework

Practice :

UKG English

Read, colour and write the words.



boots

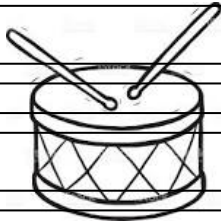

drum

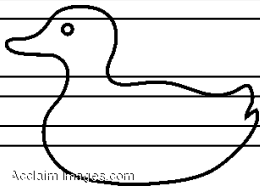

duck

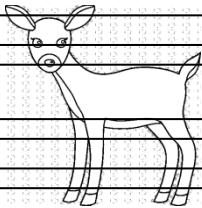

deer



bangle



fire

Classwork Date :

Homework Practice :



UKG English

Circle only the consonants,

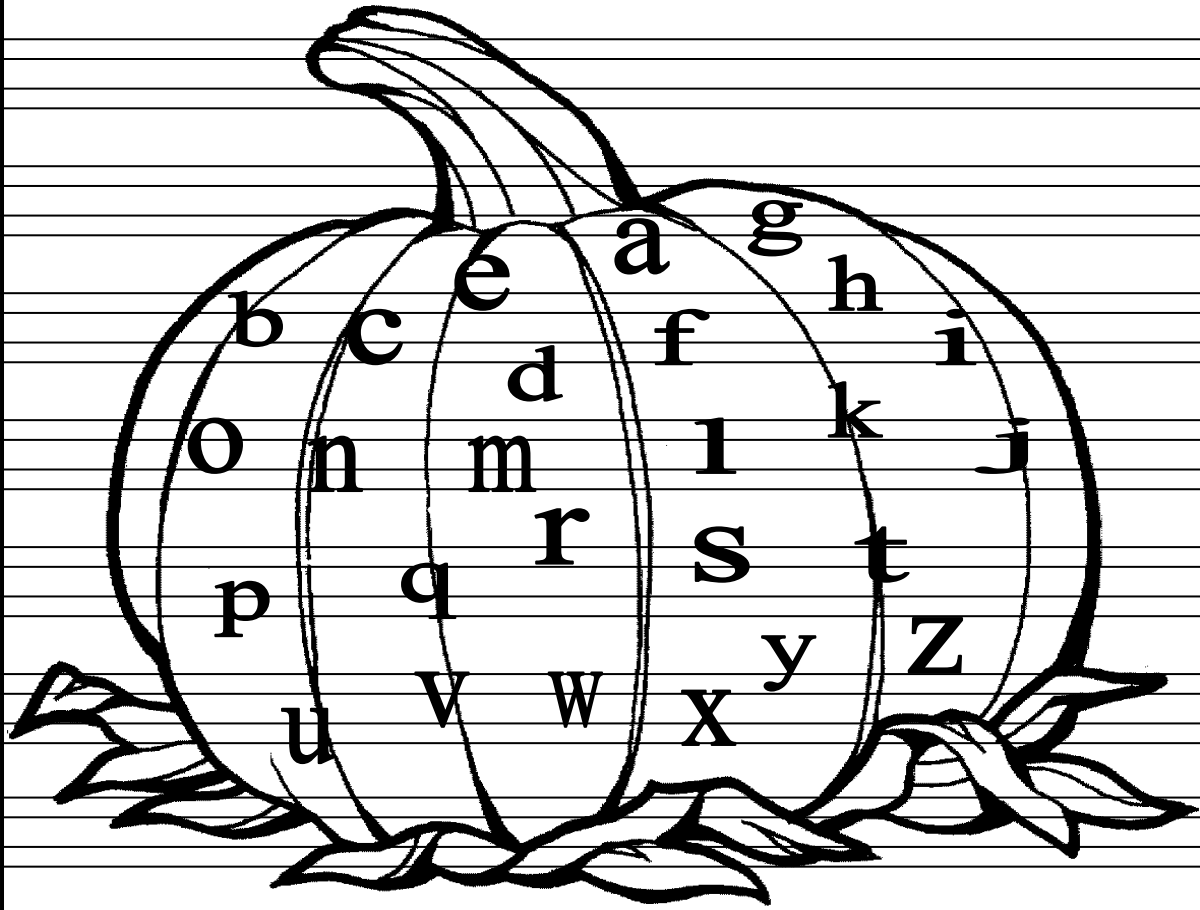

Write down the consonants.

Two rows of empty circles for writing the consonants. The first row has 13 circles and the second row has 13 circles.

Classwork Date :

Homework Practice :



UKG English

Make any six words each from the given alphabets.

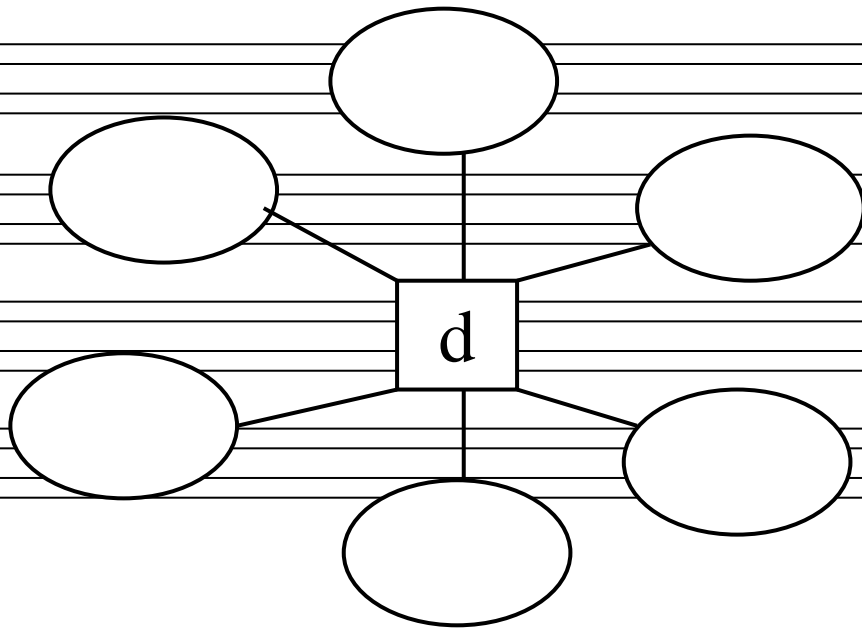
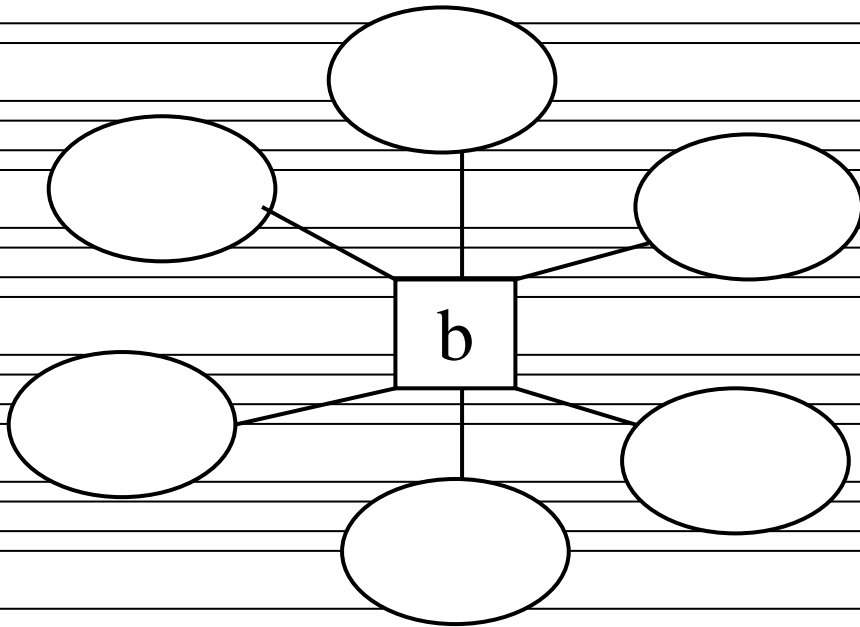

Classwork Date :

Homework Practice :



UKG English

Make any six words each from the given alphabets.

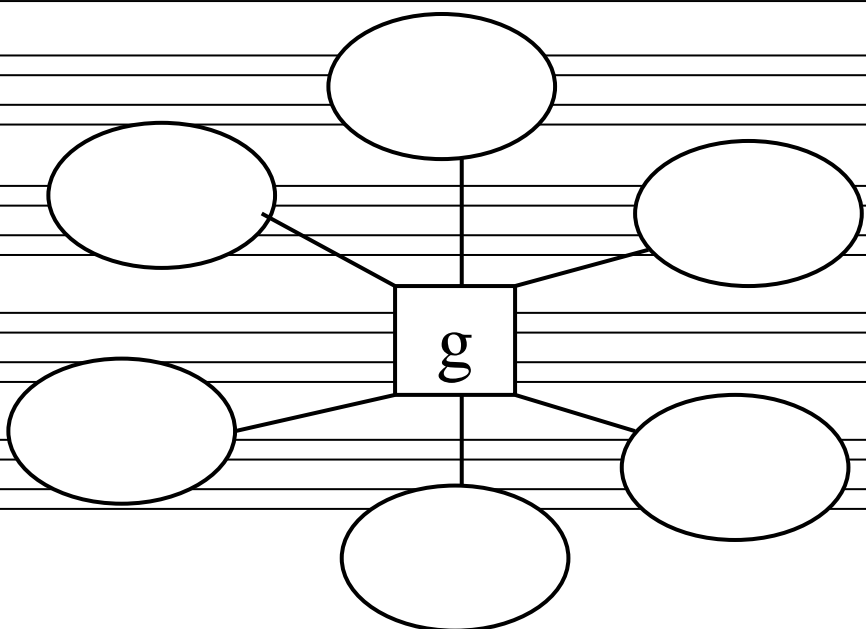
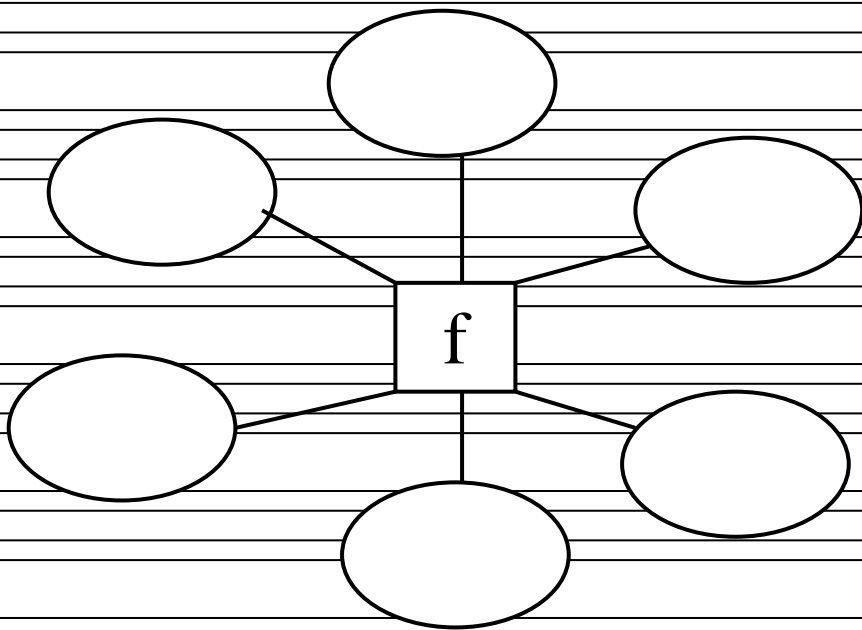

Classwork Date :

Homework Practice :



Fill in the missing letters.

.....at ar ow

.....lown amel rab

.....ouse orse oney

.....ug acket ackle

.....ing amp nife

.....emon amp amb

.....an oney onkey

.....ango anana range

.....pple row arrot

Classwork Date :

Homework Practice :



Colour and write the name of the following.

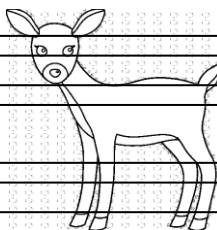
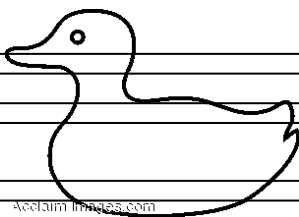
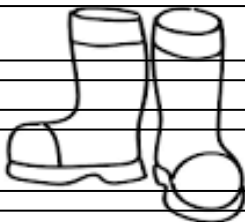
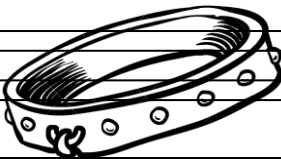
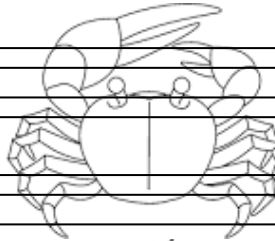
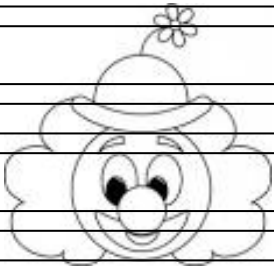
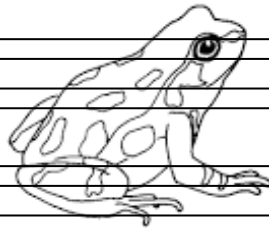
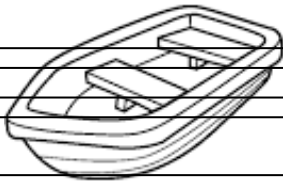

Acclum Images.com

Classwork

Date :

Homework

Practice :



Read, colour and write the words.



hug

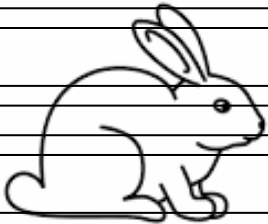

hare

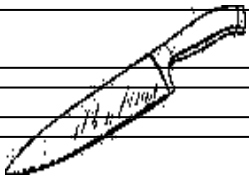

knife

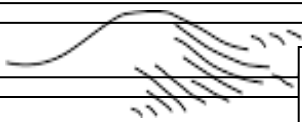

hill

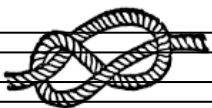

1

knot

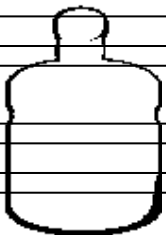

jar

Classwork Date :

Homework Practice :



Colour and write the name of the following.

